

OCTAPOLE.
THE SENSATIONAL
NEW DISPLAY SYSTEM.

exhibition systems
interior design systems
presentation systems

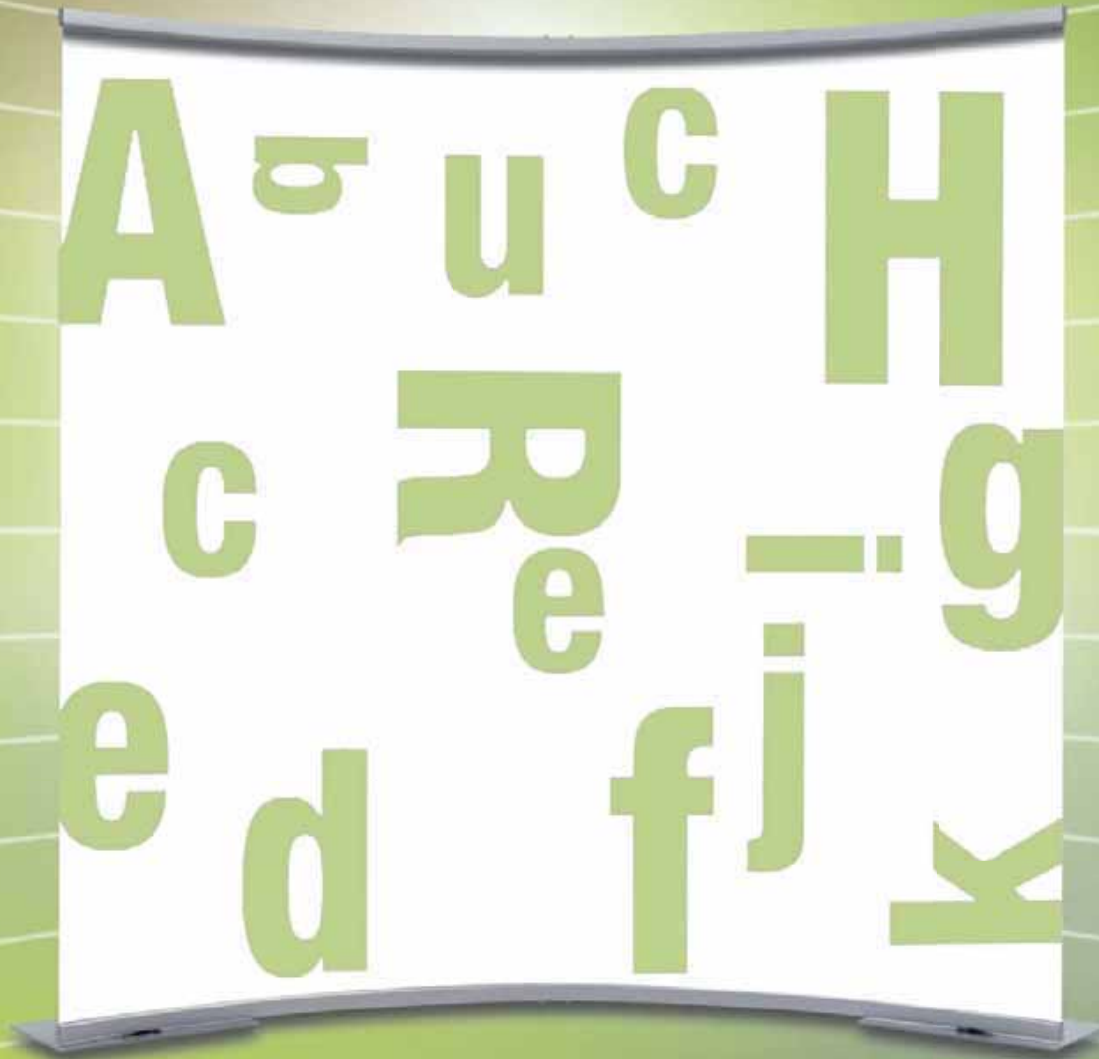

THE
WORLD
OF
SYSTEMS

OCTANORM 

.THE MOST STUNNING
PRESENTATIONS EVER.

OCTAPOLE IS THE ULTIMATE KEY TO SUCCESSFUL GRAPHIC DISPLAYS.
This ingenious banner display system offers incredible versatility
and an endless range of applications. The ideal display medium!

	ADVANTAGES		
<p>THE WORLD OF SYSTEMS</p>	Fast set-up and dismantling without tools		
	Available in two versions: curved and straight		
	Adjustable in height from 1600 - 2500 mm		
	State-of-the-art telescopic principle		
	Easy mounting of spotlights without any tools		
	Suitable accessories (shelves, literature racks)		
	Special sizes available on request		
	Double-sided compatible		
	All sets have small packing sizes (suitable for small package service)		

**.OCTAPOLE BANNER SYSTEM.
SYSTEM- AND FABRIC DIMENSIONS.**

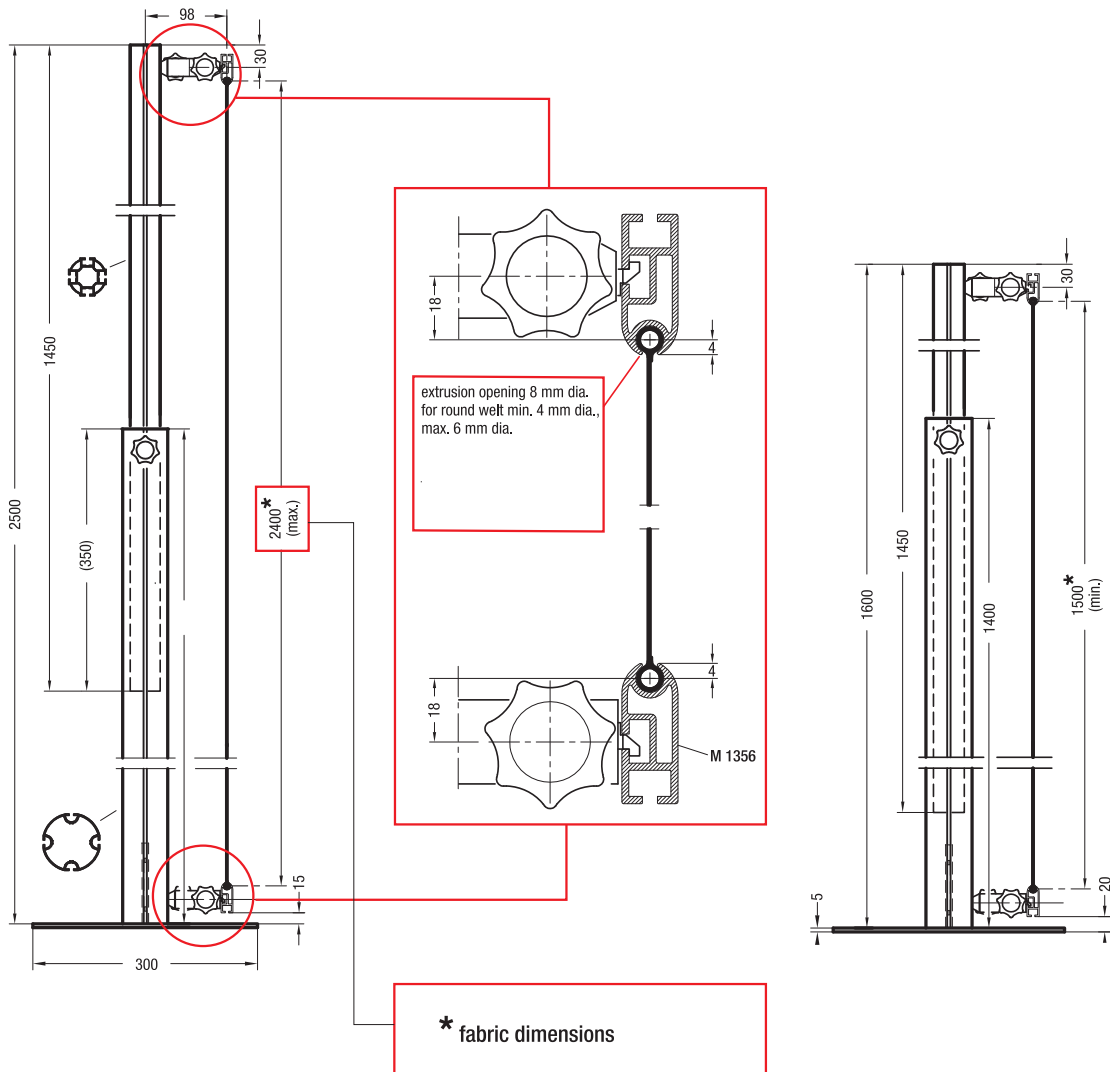

**.OCTAPOLE.
SET-PROGRAM.**

OCTAPOLE-SET / STRAIGHT VERSION

OP 10.90

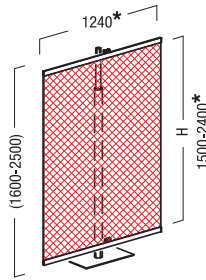

aluminium, matt anodized, silver
set includes:
1 telescopic upright OP 150
1 base plate OP 155
1 adaptor OP 158 and 1 adaptor OP 160
2 beam extrusions OP 181
4 end caps M 1365/K
Attention: graphic panel not included

OCTAPOLE-SET / STRAIGHT VERSION

OP 100.90

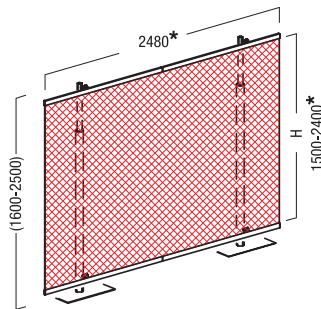

aluminium, matt anodized, silver
set includes:
2 telescopic uprights OP 150
2 base plates OP 155
2 adaptors OP 158 and 2 adaptors OP 160
4 beam extrusions OP 181
4 end caps M 1365/K
3 connectors OP 172
Attention: graphic panel not included

OCTAPOLE-SET / CURVED VERSION (CONCAVE)

OP 20.90

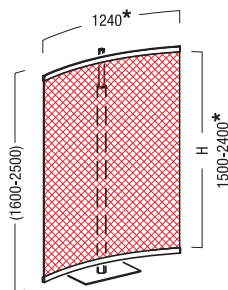

aluminium, matt anodized, silver
set includes:
1 telescopic upright OP 150
1 base plate OP 155
1 adaptor OP 158 and 1 adaptor OP 160
2 beam extrusions OP 183
4 end caps M 1365/K
Attention: graphic panel not included

* fabric dimensions



OCTAPOLE-SET / CURVED VERSION (CONCAVE)

OP 200.90

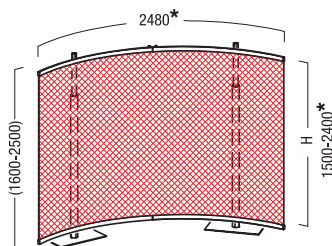

aluminium, matt anodized, silver
set includes:
2 telescopic uprights OP 150
2 base plates OP 155
2 adaptors OP 158 and 2 adaptors OP 160
4 beam extrusions OP 183
4 end caps M 1365/K
1 connector OP 174 and
2 connectors OP 176
Attention: raphic panel not included

OCTAPOLE-SET / CURVED VERSION (CONVEX)

OP 30.90

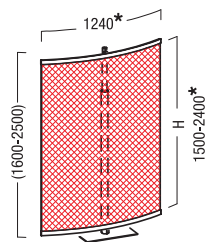

aluminium, matt anodized, silver
set includes:
1 telescopic upright OP 150
1 base plate OP 155
1 adaptor OP 158 and 1 adaptor OP 160
2 beam extrusions OP 185
4 end caps M 1365/K
Attention: graphic panel not included

OCTAPOLE-SET / CURVED VERSION (CONVEX)

OP 300.90

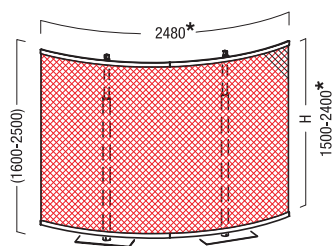

aluminium, matt anodized, silver
set includes:
2 telescopic uprights OP 150
2 base plates OP 155
2 adaptors OP 158 and 2 adaptors OP 160
4 beam extrusions OP 185
4 end caps M 1365/K
1 connector OP 174 and
2 connectors OP 178
Attention: graphic panel not included

* fabric dimensions

**.PARTS AND
ACCESSORIES.**

TELESCOPIC UPRIGHT

OP 150.01



aluminium
two-pieces, made of M 1204 and M 1210
height adjustable from 1600 mm - 2500 mm
with fixing screw

BASE PLATE

OP 155.21



steel
with adaptor for upright extrusion OP 150

ADAPTOR „TOP“

OP 158.01

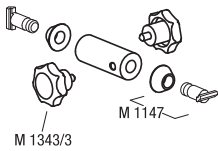

aluminium / steel
incl. 2 fixing screws M 1343/3 and
2 hammerhead bolts M 1147
70 mm long

ADAPTOR „BOTTOM“

OP 160.01

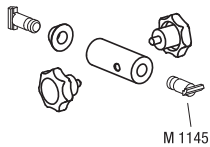

aluminium / steel
incl. 2 fixing screws M 1343/3 and
2 hammerhead bolts M 1145
60 mm long



ANGLE-CONNECTOR 90°

OP 165.37

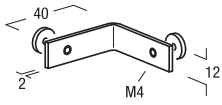

steel / galvanized
incl. 2 knurled head screws OP 172/1

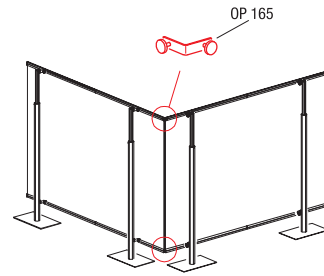

CLAMP SET

OP 170.33

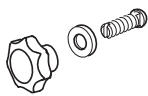

steel / plastic
thread M8
for upright extrusion OP 150



HALOGEN SPOTLIGHT

VA 5020.90

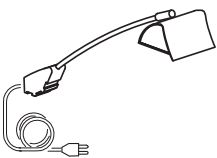

plastic / silver-grey
incl. halogen light 150 W/230 V,
connection cable 3000 mm and clamp M 1481
2.14 lbs

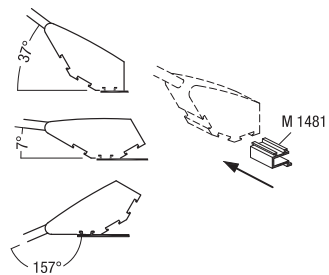

.PARTS AND ACCESSORIES.

TRANSPORT BOX

OP 191.90

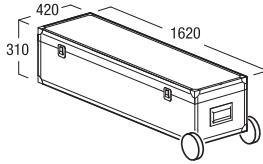

plastic / aluminium
with carry handles and castors
for all OCTApole sets
1620 x 420 x 310 mm

BEAM CONNECTOR - STRAIGHT

OP 172.00

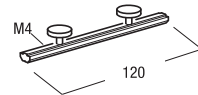

aluminium / steel
incl. 2 knurled head screws M4
120 mm long

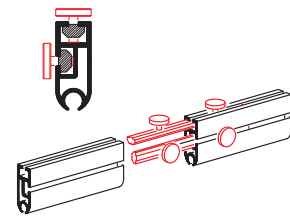

BEAM CONNECTOR - CURVED „TOP“

OP 174.00

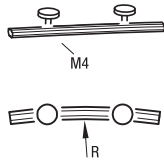

aluminium / steel
incl. 2 knurled-head screws M4
Attention: only to be used at the top
120 mm long

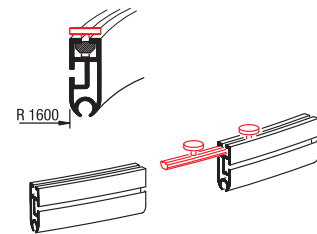

BEAM CONNECTOR - CURVED

OP 176.00

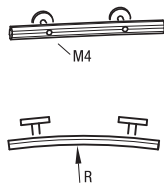

aluminium / steel
Attention: only to be used on the side
120 mm long

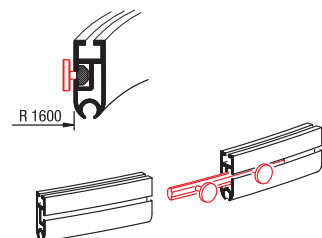



BEAM CONNECTOR - CURVED

OP 178.00

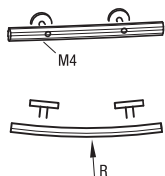

aluminium / steel
Attention: only to be used on the side
120 mm long

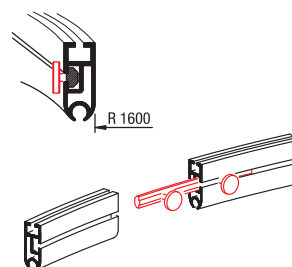

BEAM CONNECTOR - STRAIGHT

OP 180.00

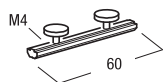

aluminium / steel
incl. 2 knurled head screws
for wave presentations,
for curved beams (R_{min} : 800 mm)
60 mm long

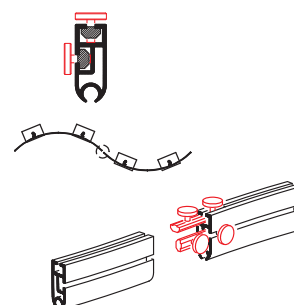

BEAM - STRAIGHT VERSION

OP 181.01

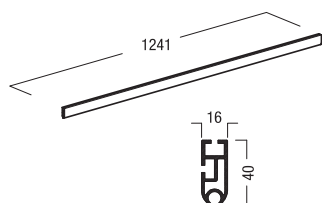

aluminium
made of extrusion M 1356
suitable for round welt min. 4 mm dia., max. 6 mm dia.
1241 mm long

.PARTS AND
ACCESSORIES.

.BAUTEILE UND
ZUBEHÖR.

BEAM - CURVED VERSION (CONCAVE)

OP 183.01

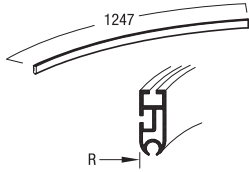

aluminium
made of extrusion M 1356
suitable for round welt min. 4 mm dia., max. 6 mm dia.
1247 mm long / outside radius 1600 mm

BEAM - CURVED VERSION (CONVEX)

OP 185.01

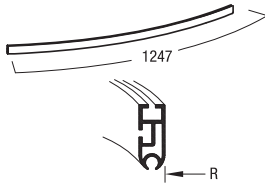

aluminium
made of extrusion M 1356
suitable for round welt min. 4 mm dia., max. 6 mm dia.
1247 mm long / outside radius 1600 mm

END CAP

M 1365/K.35

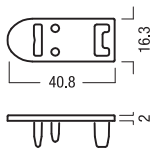

plastic
for beam extrusions M 1354 and M 1356

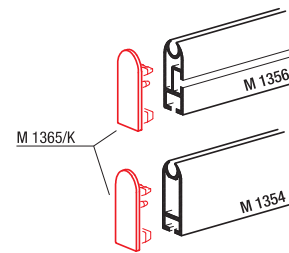

BEAM EXTRUSION 33.5 MM

M 1324.01

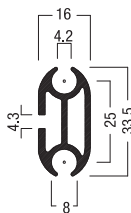

aluminium
1 system groove,
2 extrusion openings 8 mm dia. for use with inserted welt
min. 4 mm dia., max. 6 mm dia.
5000 mm long

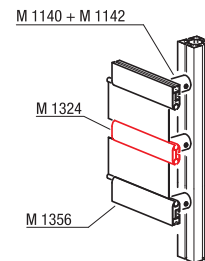

**.OCTAPOLE BANNER SYSTEM.
ORDERING EXAMPLES.**

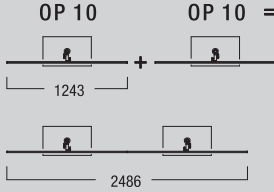
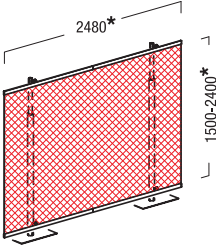
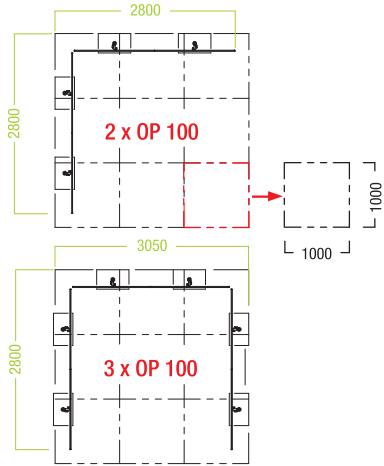
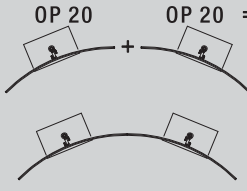
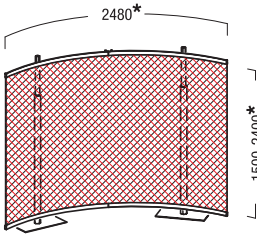
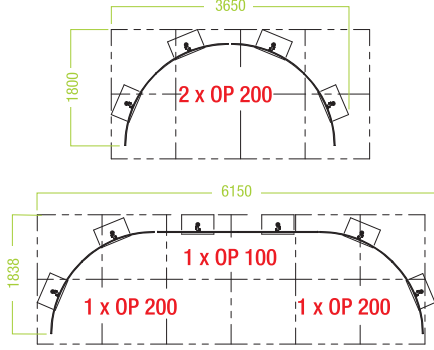
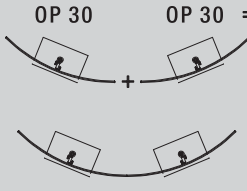
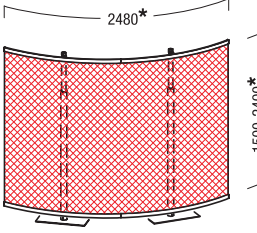
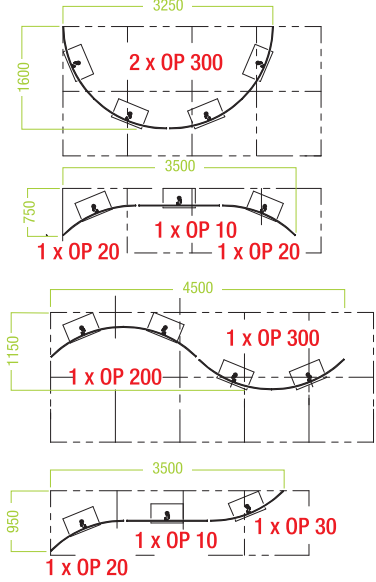

OP 100	* fabric dimensions	
<p>OP 10 + OP 10 = OP 100</p> 		
<p>OP 20 + OP 20 = OP 200</p> 		
<p>OP 30 + OP 30 = OP 300</p> 		

DESIGN EXAMPLES
WITH ACCESSORIES.



THE
WORLD
OF
SYSTEMS

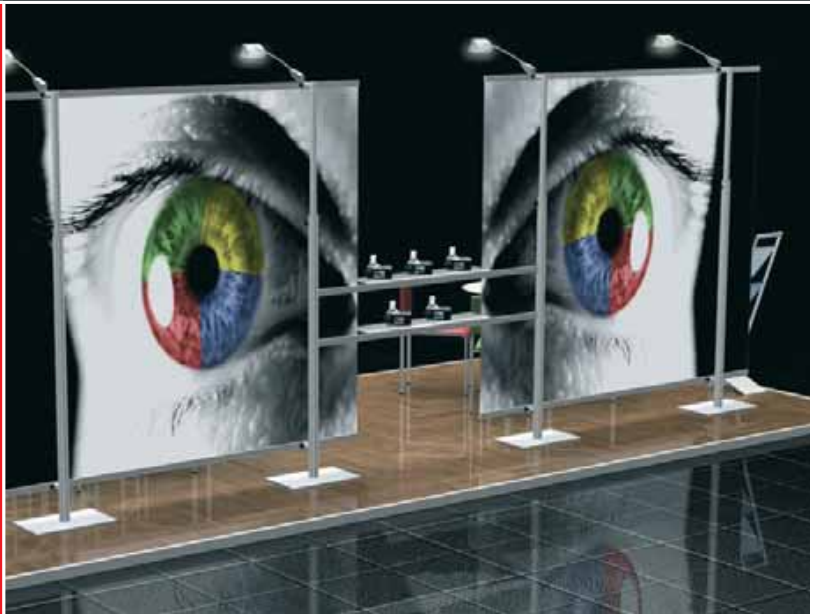



PLEASE SEE OUR OCTANORM PRODUCT CATALOGUE FOR THE COMPLETE RANGE OF ACCESSORIES.

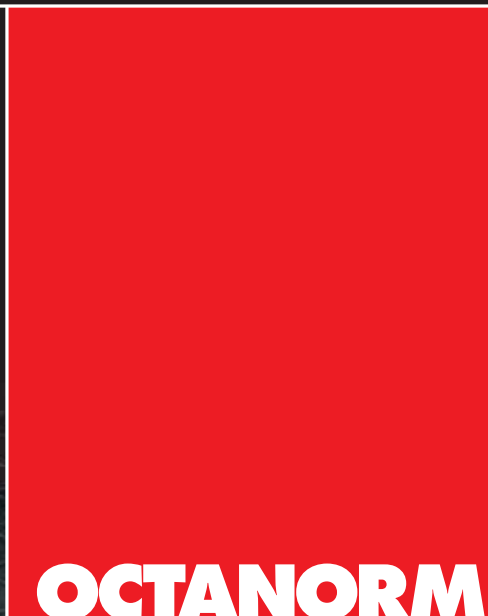

OCTANORM 

.OCTAPOLE PROVIDES
1000 NEW
APPLICATIONS.

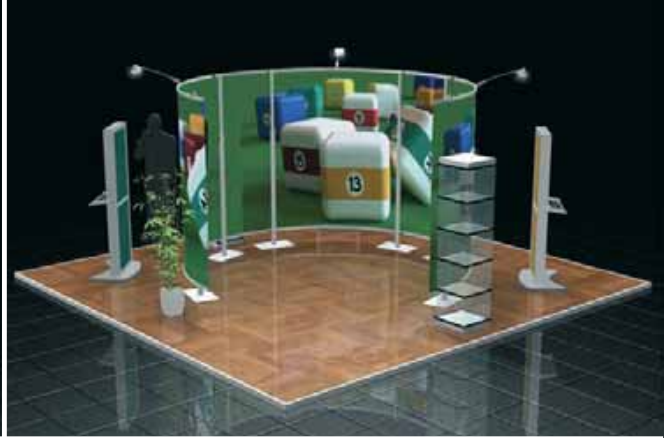
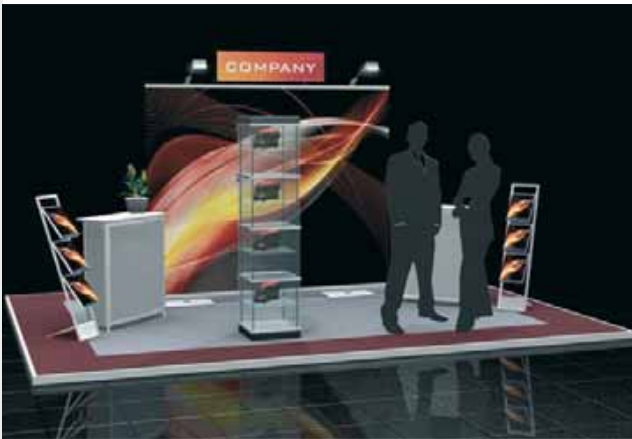

THE
WORLD
OF
SYSTEMS

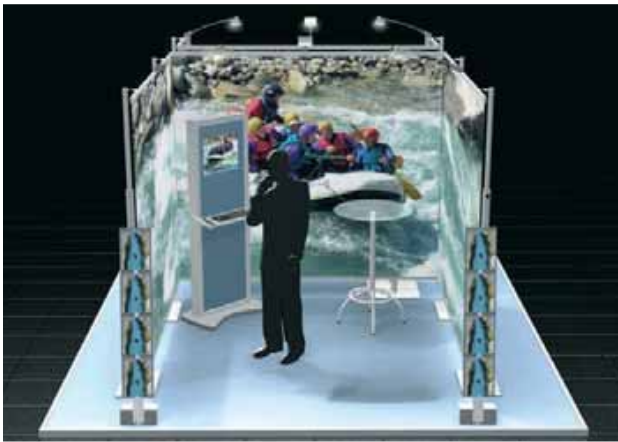

.FUNCTION
& FORM - THAT'S
OCTANORM.

exhibition systems
interior design systems
presentation systems
cleanroom systems
software and service

OCTAPOLE - THE ULTIMATE KEY
TO SUCCESSFUL GRAPHIC DISPLAYS.



AW 7940_06_2009

THE
WORLD
OF
SYSTEMS

www.octanorm.com

OCTANORM 